







NORMA® TORRO® 9 W2 Assortment (50 pcs)



The most versatile worm drive hose clamp for automotive applications

- ✓ Multi-range hose clamp
- ✓ Clamping ranges in acc. with DIN 3017:
8 mm to 160 mm
- ✓ No chromium (VI) used for coating purposes

-  Air Intake & Induction
-  Exhaust Systems
-  Cooling Systems
-  Fuel & Oil Systems
-  Turbocharger Installations
-  Fixing & Retaining

HOSE CLAMPS

NORMACLAMP® TORRO®

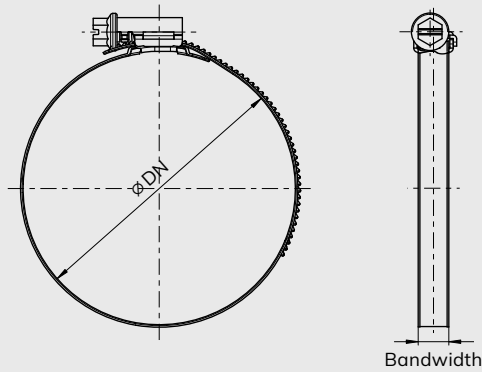

Applications

The TORRO® multi-range hose clamp is perfectly suited for demanding automotive applications. It scores with a particularly wide range of applications and reliable quality. Therefore, the TORRO® is the ideal choice for applications in the automotive sector where high mechanical loads occur.

Material

Group	W2
-------	----

Part number	Description	Clamping range \varnothing DN (mm)	Bandwidth (mm)	Packaging quantity (pcs)
0126 9702 050	NORMA® TORRO® 9 W2 Assortment (50 pcs)	8–60	9	1
The assortment contains:				
0126 7702 013	TORRO® 8-16/9 C7 W2	8–16	9	5
0126 7702 017	TORRO® 12-22/9 C7 W2	12–22	9	8
0126 7702 021	TORRO® 16-27/9 C7 W2	16–27	9	10
0126 7702 026	TORRO® 20-32/9 C7 W2	20–32	9	5
0126 7702 032	TORRO® 25-40/9 C7 W2	25–40	9	12
0126 7702 041	TORRO® 32-50/9 C7 W2	32–50	9	5
0126 7702 050	TORRO® 40-60/9 C7 W2	40–60	9	5

Technical benefits

- ✓ Ideally suited for applications with high mechanical loads
- ✓ Hose-friendly design thanks to embossed band and rounded band interiors
- ✓ Even distribution of clamping forces prevents leaks

NORMA® TORRO® 9 W2 Assortment (50 pcs)
is part of a broad portfolio. Discover more!



NORMA® TORRO® WF W3 Assortment (50 pcs)



NORMA® Fuel Line Repair Kit



Do you have questions or require a personal consultation?

Feel free to contact our Norma Team! Tel.: +49 6181-403-0

Visit our website for more information about our products: www.norma-connects.com

